



The LPE trucks within the Orion Range are ideally suited for high performance applications regarding dock loading / cross-docking / horizontal transportation. Excellent man-machine interface combined with the LPE trucks dynamic characteristics provides a base for high productivity.



Technical Details		LPE200, 6 km/h	LPE200, High performance	LPE240
Rated capacity	kg	2000	2000	2400
Load centre	mm	600	600	600
Weight without battery	kg	405	420	730
Max. axle load drive wheel, without/with rated load	kg	350/550	350/550	510/835
Max. axle load castor wheels, without/with rated load	kg	60+60/205+205	70+70/215+215	150+150/295+295
Max. axle load fork wheels, without/with rated load	kg	65+65/820+820	65+65/820+820	105+105/1075+1075
Castor wheels, polyurethane	mm	Ø 125x40	Ø 125x40	Ø 150x50
Fork wheels, single or bogie, Vulkollan	mm	Ø 85	Ø 85	Ø 85x75 ¹⁾
Drive wheel, Vulkollan ²⁾	mm	Ø 215x70	Ø 215x70	Ø 250x75, 250x105
Travel speed, without/with 1000kg/with rated load	km/h	6.0/—/6.0	8.5/—/7.5	12.0/12.0/8.0 ³⁾
Lift speed fork, without/with rated load	m/s	0.07/0.05	0.07/0.05	0.06/0.04
Lowering speed fork, without/with rated load	m/s	0.09/0.08	0.09/0.08	0.04/0.04
Gradient, without/with rated load	%	18/8	18/8	15/8
Service-/parking brake		electric	electric	electric
Drive motor/Intermittent rating	kW/%	1.2/60	1.7/60	2.5/60
Lift motor/Intermittent rating	kW/%	2.2/10	2.2/10	2.2/10
Steering system		steering arm	steering arm	steering arm
Speed control, number of steps		stepless	stepless	stepless
Steering arc	°	200	200	180

Dimensions, mm		LPE200	LPE240
h ₂₃	Total lift height	205	210 ⁴⁾
x	Front axle to fork front face, fork raised	892	909 ⁴⁾
h ₂₃	Total lift height	—	225 ⁵⁾
x	Front axle to fork front face, fork raised	—	886 ⁵⁾
h ₇	Platform height	150	184
h ₁₄	Height of handle in neutral pos.	1370	1450
h ₁₃	Height of lowered fork	85	85
e	Fork width	180	180
l	Fork length	800/1000/1150/1200/1450/1550/1950/ 2150/2350	800/950/1000/1150/1200/1450/1550/ 1950/2000/2150/2350
b ₅	Width across fork	450/520/536/550/570/685	450/520/536/550/685
l ₄	Platform length	458	422
m ₁	Floor clearance	30	55

- 1) Single wheels upto and including l=1450 mm
- 2) Other alternatives available
- 3) With rated load, small battery compartment: Travel speed = 8.5 km/h
- 4) Pallet handling
- 5) Roll cage handling

Data is based on standard battery compartment, medium size, l=1150 mm

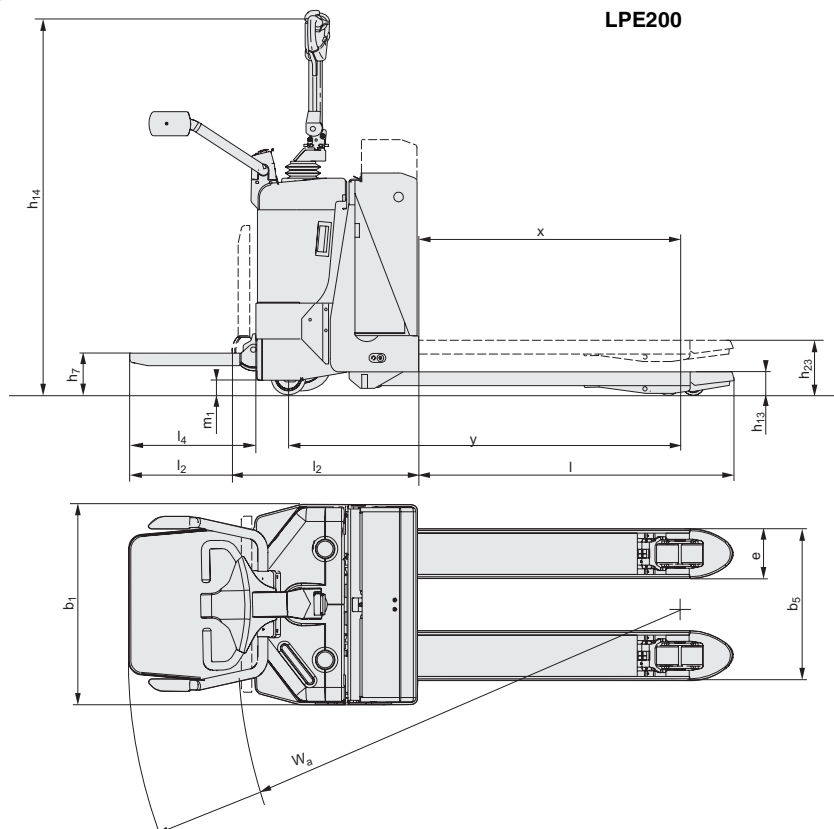

Dimensions — standard battery compartment			LPE200		LPE240	
			Battery compartment		Battery compartment	
			Medium	Large	Small	Medium
y	Wheel base, fork raised/lowered	mm	1313/1377	1361/1425	1605/1725	1691/1811
l_2	Truck length incl. back of fork, platform up/down	mm	677/1051	725/1099	745/1167	831/1253
b_1	Chassis, width	mm	726	726	790	790
A_{st}	Aisle width, min., platform up/down Pallet 800x1200 mm	mm	2013/2387	2061/2435	2265/2687	2351/2773
W_a	Turning radius, platform up/down	mm	1569/1943	1617/1991	1725/2147	1811/2233
	Battery capacity, min./max.	Ah	180/240	280/320	300/465	300/620
	Voltage	V	24	24	24	24
	Battery weight, min./max.	kg	150/210	200/250	250/380	250/380

Dimensions — sideway exchange battery compartment			LPE200		
			Battery compartment		
			Medium	Large	DIN
y	Wheel base, fork raised/lowered	mm	1345/1409	1395/1459	1445/1509
l_2	Truck length incl. back of fork, platform up/down	mm	709/1083	759/1133	809/1183
b_1	Chassis, width	mm	755	755	755
A_{st}	Aisle width, min., platform up/down Pallet 800x1200 mm	mm	2109/2483	2159/2533	2209/2583
W_a	Turning radius, platform up/down	mm	1665/2039	1715/2089	1765/2139
	Battery capacity, min./max.	Ah	210/240	280/320	240/330
	Voltage	V	24	24	24
	Battery weight, min./max.	kg	150/210	220/250	210/300

Truck performance and dimensions are nominal and subject to tolerances.
 BT Products AB products and specifications are subject to change without notice.
 All data is based on VDI 2198.

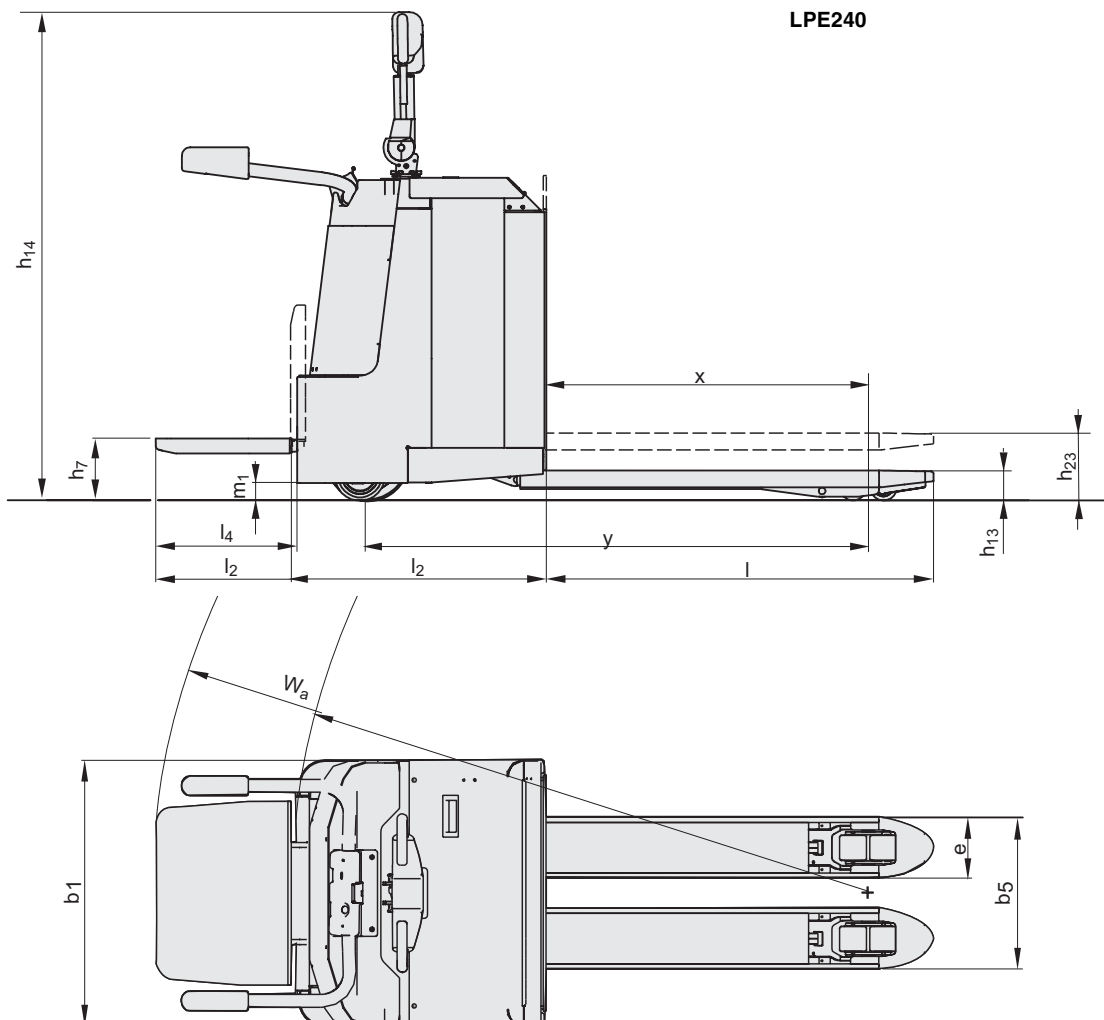



- The truck is equipped with Powertrak drive unit configuration — a BT patent. The drive wheel pressure is constantly adjusted due to the weight of the load. The result is optimal traction and minimum steering force.
- Integrated spring loaded, foldable platform together with stable and comfortable gates provides safe high speed operation and maximum efficiency.
- The comfortable steering arm, with its modern design, facilitates one hand operation. The lift, lowering and driving functions are ergonomically placed on the steering arm and can be operated by finger tip force.
- The BT Powerdrive system provides smooth and effortless driving, quick reliable information and easy programmable performance of the truck — to suit the driver and application.
- Individual driver parameters, top speed, acceleration and automatic speed reduction, to meet driver skills can be programmed via the key pad (no tool needed).

Truck features	LPE200	LPE240
BT Powerdrive System	S	S
Climber wheels	O	O
Powertrak traction system	S	S
Controls and instrument		
Fingertip controls	S	S
Information display	S	S
Driving features		
Electronic braking system	S	S
Electronic regenerative brakes	S	S
Electronic speed control	S	S
Safety features		
Automatic parking brake	S	S
Driver detection system	S	S
Fixed sideguards	O	O
Folding sideguards	O	S
Load support	O	O
Drivers compartment features		
Writing table	O	O
Maintenance features		
Easy access for maintenance	S	S
Fault diagnosis facility	S	S
Historic fault log	S	S
Lubrication points	S	S
Battery management features		
Battery change facility	O	O
Battery status indicator	S	S
Built-in charger	O	—
Heavy duty battery compartments	—	S
Sideways battery change	O	O

S = Standard feature

O = Optional feature

— = Not available

BT
 SE-595 81 Mjölby Sweden
 Tel: +46 (0)142 860 00
 Fax: +46 (0) 142 866 00
 Email: info@bt-forklifts.com
 www.bt-forklifts.com

